

Lightruss®



An innovative solution for today's lighting challenges. Lightruss combines a modular truss support system and performance lighting modules to deliver illumination for even the most unusual and demanding applications. Transition modules allow the truss system to flow around corners, change elevations and convert from indirect to direct illumination.





Lightruss systems illuminate over 700 facilities across North America. In addition to being a unique, performance level lighting system, Lightruss' standard features help save roughly 25 to 30 percent in installation time and money, when compared to independently hung fixtures. Let our team of experts create the ultimate lighting system for your application.



Lightruss®

Interior



Ozaukee Ice Center, WI

Product	Size	Forward Throw	Asymmetric	Symmetric	Wide Symmetric	Truss	Fluorescent Wattage Range	Metal Halide Wattage Range	Tungsten Halogen Wattage Range
Lightruss	1	●	●	●		●	2F39 - 4F54	1M70 - 1M400	1T150 - 2T250
	2	●	●	●	●	●	3F28 - 6F54	1M175 - 1M1000	2T250 - 4T250



FEATURES AND OPTIONS



Acrylic Prismatic Diffuser Lens



Downlight Louver



Wall Washer

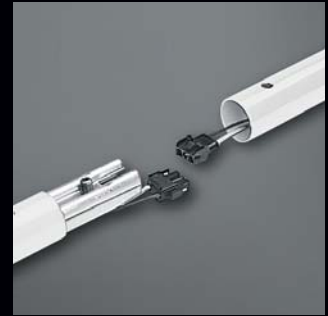

Wire Raceway Detail

Features

- Alternative Bulkhead Forms
- Creative Finish Options
- Durable Powder Coat Finish
- Convenient Installation
Saves Time and Money
- Eliminates Water Glare
- Fewer Power Drops
- Hi-Pot and Continuity
Tested at Factory
- Pre-Assembled
- Pre-Wired
- Supports Mounted Audio
Equipment and Accessories

Flexible Ballast Options

- Integral
- Electronic and Magnetic

Premium Reflectors

- 95% Reflective Aluminum

UL Listing

- UL Listed (US & Canada)
for Damp Locations
(Not recommended for
exterior use)
- UL Listed (US & Canada)
as a Raceway and Wireway

Standard Options

- Acrylic Prismatic Diffuser
Lens
- Dimming (Fluorescent only)
- Downlight Louver
- Encapsulated Core and
Coil Power Tray™
- Fusing
- Integral Emergency
- Quartz Emergency Light
Circuit
- Standby Quartz Lighting

Customization

- Bulkhead Forms
- Alternative Mounting
- System Layout
- Ballast Specification
- And More

Contact us at 262-242-1420
or visit www.specspi.com
for more information.

INTERIOR LIGHTRUSS

Size 1



Forward Throw
Asymmetric
Symmetric

Pages
34 - 47

Size 2



Forward Throw
Asymmetric
Symmetric
Wide Symmetric

Pages
34 - 47

Lightruss®

Why using Lightruss just makes sense.

Lightruss Features

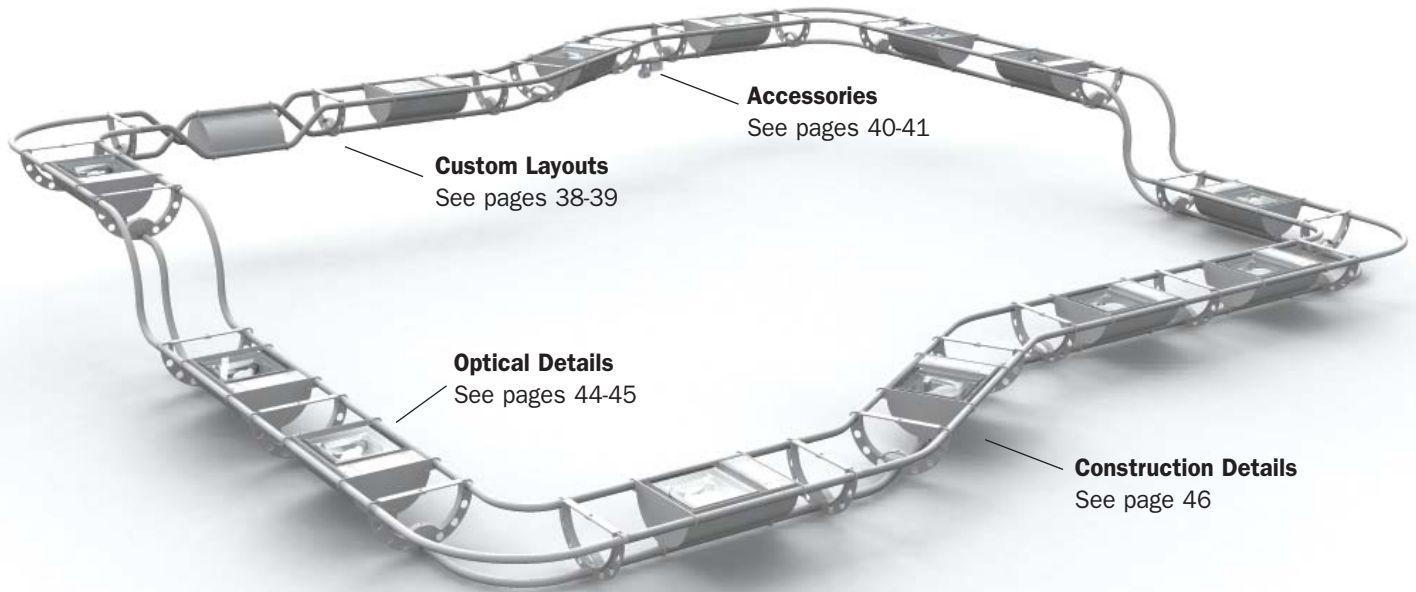

Why choose Lightruss?

Custom tailored to your specific job requirements, Lightruss can turn corners, change elevation, provide indirect lighting, invert for direct lighting and be finished to make a statement or blend into a space. Using optical systems, lamping options and spacing criteria, our dedicated team designs each Lightruss to suite the projects specific needs and even inspects each system before shipment. Whether you need IES recommended light levels for a recreational water park atmosphere or for digital TV sports coverage, Lightruss can deliver. Precision merchandising requires increased visibility and attraction. Lightruss systems can create that distinct look, as well as deliver the footcandles needed to achieve showroom quality illumination.

• Easy Installation Saves Time and Money

- Fewer power drops
- Hi-pot and continuity tested at factory
- Pre-assembled
- Pre-wired
- Integrally mounted ballast / Power Trays™

• Application and Design Support

- Full engineering support from our Lightruss team

• Add Architectural Interest

- Create your own custom shape and layout
- Add color

• Customization

- Light challenging spaces with unique layouts
- Supports mounted audio equipment and accessories

• Sizes Appropriate for Any Space

- Size 1 and 2
- Wide HID, fluorescent and quartz lamping ranges

• Durable Construction

• Finishes

- Durable powder coat finish
- Natatorium finish

• Optical Control

- Multiple optical distributions
- Direct and indirect lighting combinations

• Emergency

• Dimming

• Shielding Options

Cost and Time Savings

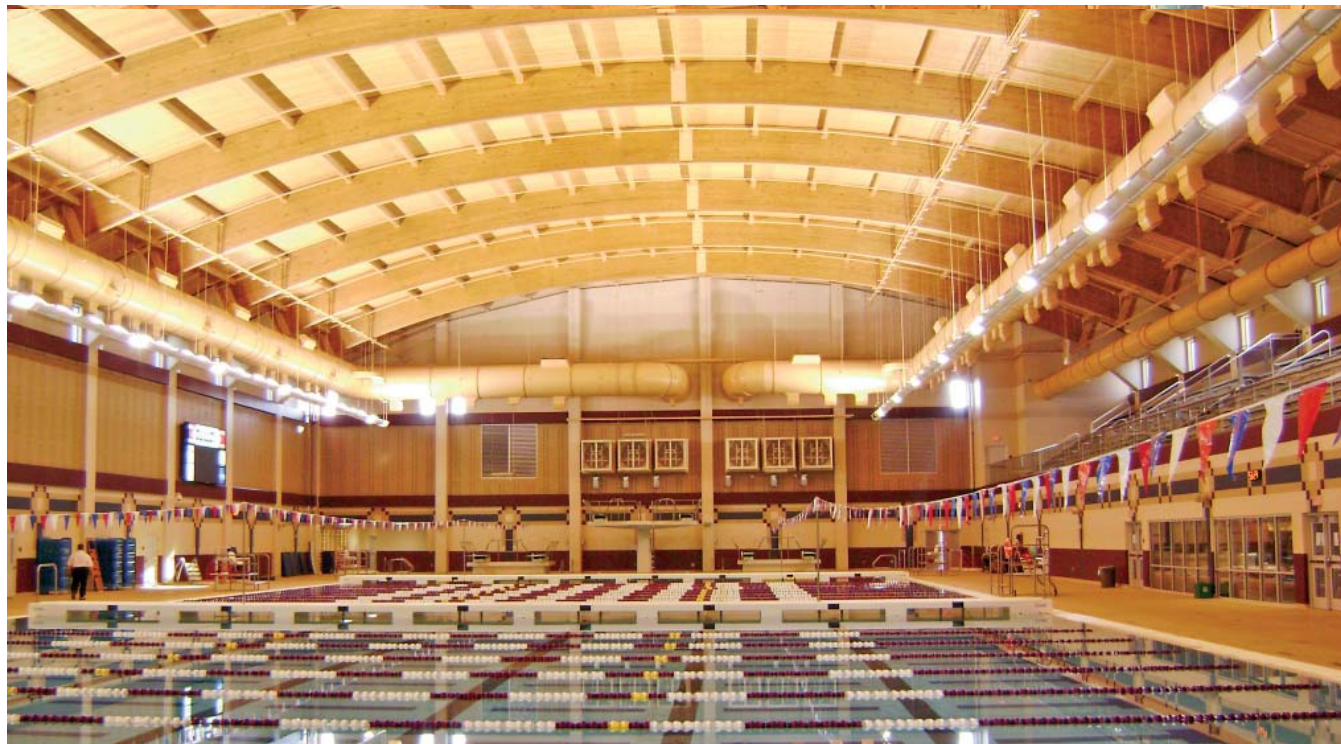

Lightruss does more than provide high-quality lighting; it saves you time and money. When installing Lightruss, compared to individually hung fixtures, you will save an estimated 25 to 30 percent in installation time and money. Consider the following:

Prior to Installation (At factory)

- Built with integrally mounted Power Trays™
- Pre-wired
- Pre-assembled
- Pre-aimed
- Hi-pot and continuity test complete

During Installation

- Installers level, plug and move onto the next section
- Fewer power drops (typically two to four per system, depending on the size)

Lightruss Installation Quick Facts

- Starter section 30 minutes
- Common section 20 minutes



Do the Math

Typical Competition Pool - 75' x 45'

40 Lightruss Sections (Approx.)
 2 Installers
 + 1 Lift

20 Hours (Approx.)

Lightruss®

Our Lightruss team provides full service.

Full project support - start to finish.

BEFORE



PROJECT CHALLENGES

The current lighting solution presents the following problems:

- **Light Levels**
 - Low light levels create unsafe environments for occupants.
 - Dark, cave-like feel.
- **Direct Lighting**
 - Direct lighting over deck creates shadowing at the pool center.
 - Downlights create surface glare.
- **Pool Safety**
 - Water glare obstructs a lifeguards view to the pool bottom.

SPECIFICATION PROCESS

SPI's dedicated and experienced Lightruss team provides total service from initial inquiry through final installation.

START

Lightruss Introduction

SPI provides application photographs, budget parameters and references from similar projects. A video presentation is available explaining Lightruss and its many features and advantages.

Application Requirements

One of our Lightruss application engineers will interface with you and your design team to obtain the illumination and space parameters needed to begin the system design.

DESIGN PHASE

Construction Documentation

A complete set of documentation will be provided for inclusion in your bid. Overall layouts, circuiting diagrams and construction details are supplied.

Bidding

Our local representatives, in association with our Lightruss team, provide final project pricing, and can walk contractors through the installation process to assure they are comfortable with how the system is supplied and installed.

Consultation

SPI's Lightruss team offers consultation on our lighting system, as well as our competitors, to ensure an informed decision is made.



Lightruss

Truss

AFTER



LIGHTRUSS SOLUTIONS

The Lightruss system addressed all existing challenges, reduced risk, eliminated unnecessary expenses and increased safety.

- **Light Levels**
 - A well-lit space, utilizing even indirect lighting, increased occupant comfort and safety.
- **Indirect Lighting**
 - Lightruss indirectly distributes light over the pool with asymmetric optics.
 - Fixtures located over pool deck minimize maintenance time and expense, as well as pool down time.
- **Pool Safety**
 - Surface glare was eliminated, allowing lifeguards to see directly to the bottom of the pool.

INSTALLATION

System Construction

Lightruss is pre-wired, each light module is aimed and every section is pre-assembled at the factory. Each section is also individually packaged for shipment and ease of handling.

Installation

Each package and component is keyed to the installation drawings so all components are easily identified at the job site.

FINISH



From the Field

The quality and performance of the SPI Lighting Lightruss system is the best in the industry. They are the only manufacturer I know of who has a specific team dedicated to one product line. They handle design, photometric layouts, shipping and customer service all in one neat package. They are very professional and are a great asset to a company like ours.

- TSR Lighting

Truss

Lightruss®

Make an architectural statement.

Form, color and function.



Get creative.

Lightruss systems can twist and turn to create functional works of art. Unique, custom sculptural forms can be realized with standard Lightruss building blocks (see page 39). But don't stop there, add splashes of color by selecting any of our durable, eco-friendly powder coat paints. Whether Lightruss is used to create a bold statement or quietly blend in, you can always count on it to provide quality, high-performance illumination.



Create your vision.



The Building Blocks

Starter

- (3) Tubes with connectors
- (2) Bulkheads
- (1) Custom length stem (power feed)
- (1) Adjustable cable
- (2) Canopies



Common

- (3) Tubes with connectors
- (1) Bulkhead
- (1) Adjustable cable and canopy



End

- (3) Tubes with connectors



Wall Mount

- (3) Tubes with connectors
- (1) Wall-mounted bulkhead and cover



T-Module

- (3) Tubes with connectors
- (2+) Bulkheads
- (1) Adjustable cable and canopy



Elevation Change

- (3) Tubes with connectors
- (1) Adjustable cable and canopy
- (1) Bulkhead



90° Radius

- (3) Tubes with connectors
- (1) Bulkhead
- (1) Adjustable cable and canopy



45° Radius

- (3) Tubes with connectors
- (1) Bulkhead
- (1) Adjustable cable and canopy



Twist

- (3) Tubes with connectors
- (1) Bulkhead
- (1) Adjustable cable and canopy



Half Twist

- (3) Tubes with connectors
- (1) Bulkhead
- (1) Adjustable cable and canopy



Lightruss®

More than just a lighting system.

Versatile. Flexible. Adaptable.



This versatile system offers extensive design opportunities with its ability to round corners, accommodate elevation changes, wall mount for a cleaner ceiling and invert to provide a direct light source. A solid tube spacer section is also available to blend the lighting system with other architectural elements in an environment.

Lightruss' flexibility allows it to adapt to an application by incorporating emergency lighting, audio hardware or other features required for that space. Accent lighting to illuminate graphic elements and architectural details can be achieved by incorporating a custom wall-washing light modules into the system, or by adding track lighting.



Lightruss was strategically designed to be a base that a multi-purpose, integrated ceiling system can be built upon. Accessories can mount directly to the truss system and additional electronics can safely and easily run the necessary wiring and multiple circuits through Lightruss' auxiliary tubes.

Audio Equipment

Speakers can be mounted to the truss system or an empty lighting module can be provided for installation. Truss tubing is able to house the wiring from electronic accessories.

Theatrical and Track Lighting

Accent and dramatic lighting can be mounted to and integrated into a Lightruss system for the desired lighting effects and convenient maintenance. Truss tubing acts as a raceway and is able to house the wiring from additional lighting components.

Banners, Flags and Signage

Most banners, flags and other signage can be hung from the truss structure without added mounting points within the space.

Motion Sensor

Equipment such as motion sensors can mount directly to the Lightruss system and reduce energy consumption when the space is not in use.

Security Equipment and Lighting

Mount surveillance equipment to the truss system for added security. Recording equipment can be placed within an empty light module for ease of maintenance. Separate circuiting can be provided through the truss tubes for security, night and emergency lighting.

Wall-Washing

Illuminate graphic elements and architectural details by incorporating wall-washing light modules or track lighting into the system.

Accessories



Lightruss®

A size for every space.

No space is too large or too small.

In order to accommodate projects of any scale, Lightruss systems are offered in two coordinating sizes. Each system can house forward throw, symmetric or asymmetric optics. These premium reflectors, paired with a variety of lumen packages, are able to meet the illumination requirements of any application.





Lightruss

Truss

Available Sizes

Lightruss is offered in two complementing sizes. Size 1 is designed for more compact areas such as retail spaces, cafeterias and corridors, while Size 2 is more appropriate for larger areas such as airports, athletic facilities, natatoriums and shopping malls.



1 Size 1

Size 1 complements the larger Lightruss system and provides indirect illumination in more compact environments such as retail spaces, stairwells, office areas and cafeterias. Size 1 Lightruss was designed for areas where corrosion is not a primary concern. Consult our factory if a natatorium paint finish is required. The light modules accommodate a variety of optical systems and lumen packages up to 400W metal halide, 250W quartz or 55W fluorescent.

2 Size 2

This size 2 Lightruss system is appropriate for large-scale areas such as athletic facilities, natatoriums, airport terminals, shopping malls, open office areas and large public spaces. Designed to withstand corrosive environments, such as natatoriums and underground transit facilities, this system uses non-corrosive hardware and all aluminum components are anodized and polyester powder coat painted. The Lightruss 2 modules can house single or dual lamp units with up to 1000W metal halide, 250W quartz and 80W fluorescent lamps.

Because experience matters...



Dimensions Size 1

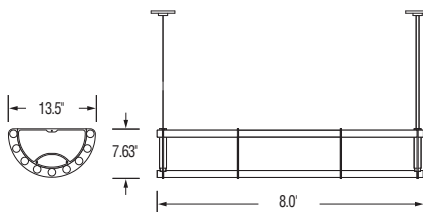
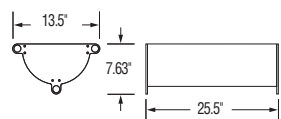

Dimensions Size 2

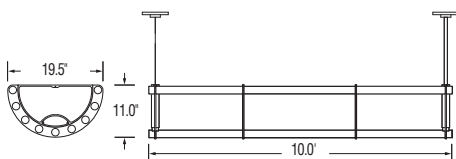
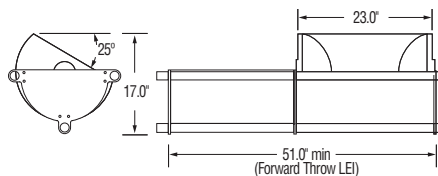
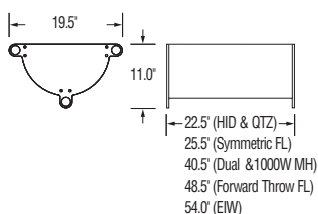

Nearly 30 years of applications experience.
Over 700 installations across North America.

Notable Projects

- Georgia Tech Sacs Pools
- University of Maryland, Campus Rec Center
- University of Michigan
- Cyber Center, Hong Kong
- VOB BMW Showroom
- University of Georgia Stegman's Building
- Akron General Medical - Cardio, Therapy Pool and Lap Pool
- Kentucky State University
- W.R. Wheeler Service Center
- McConnell Heart Health Center
- Miller Park
- Middle Tyger YMCA
- Orchard Hills Church
- Ozaukee Ice Center
- USC Columbia

Truss

Optical Distributions

Lightruss reflectors create three optical distributions: forward throw, asymmetric and symmetric. These reflector-controlled light distributions, used in conjunction with a variety of lumen packages, provide the flexibility necessary to meet a project's illumination requirements.

Forward Throw

HID/QTZ

This optic projects light into a space. Ideal for delivering indirect illumination to the work plane with the highest level of usable light, Lightruss' forward throw optic minimizes the brightness on the surface planes near the luminaire.



Single Lamp



Dual Lamp

Asymmetric

HID/QTZ

In addition to projecting light into a space to provide indirect work plane illumination, Lightruss' asymmetric optics provide both ambient backlight on a vertical mounting surface and architectural highlighting of the ceiling plane.



Single Lamp



Dual Lamp

Symmetric

HID/FL/QTZ

Lightruss offers two unique light distributions created with symmetric optical systems. The traditional symmetric optic provides a directed light distribution used to deliver indirect illumination to the work plane, while architecturally highlighting the ceiling plane. The wide symmetric "batwing" distribution projects light at low angles, providing superior ceiling uniformity and maximizing fixture spacing.



Single Lamp



Dual Lamp

Distribution Curves

Forward Throw

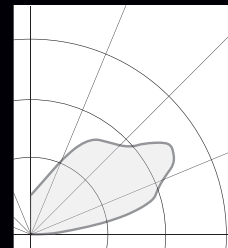

Asymmetric

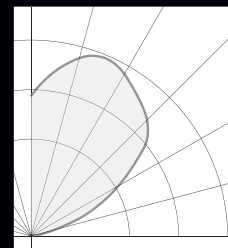

Symmetric

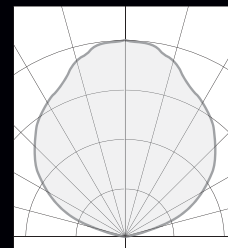

Wide Symmetric

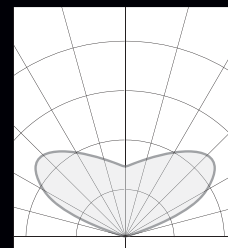



Lightruss

Truss

Lamping Size 1

Forward Throw

LEI



- 1203** (1) 70W T6 G12 MH
- 1403** (1) 150W T6 G12 MH
- 1723** (1) 150W T4 DC BAY QTZ
- 1753** (1) 250W T4 DC BAY QTZ

Asymmetric

LFA



- 1403** (1) 175W PS MH
- 1503** (1) 250W PS MH
- 1303** (1) 320W PS MH
- 1603** (1) 400W PS MH
- 1743** (2) 250W T10 Med QTZ

Symmetric

LFA



- 1401** (1) 175W PS MH
- 1501** (1) 250W PS MH
- 1301** (1) 320W PS MH
- 1601** (1) 400W PS MH
- 1741** (2) 250W T10 Med QTZ

Symmetric Fluorescent

LFL



- 1831** (2) 39W TT FL
- 1841** (2) 40W TT FL
- 1851** (2) 50W TT FL
- 1861** (2) 55W TT FL
- 1871** (3) 39W TT FL
- 1881** (3) 40W TT FL
- 1891** (3) 50W TT FL
- 1801** (3) 55W TT FL
- 1454** (4) 54W T5HO FL



See page 43 for module dimensions.

Lamping Size 2

Forward Throw

LEI



- 2403** (1) 175W PS MH
- 2503** (1) 250W PS MH
- 2313** (1) 315W PS MH
- 2303** (1) 320W PS MH
- 2603** (1) 400W PS MH
- 2743** (2) 250W T10 Med QTZ

Asymmetric

LFA



- 2403** (1) 175W PS MH
- 2503** (1) 250W PS MH
- 2303** (1) 320W PS MH
- 2603** (1) 400W PS MH
- 2743** (2) 250W T10 Med QTZ

Symmetric

LFA



- 2401** (1) 175W PS MH
- 2501** (1) 250W PS MH
- 2301** (1) 320W PS MH
- 2601** (1) 400W PS MH
- 2741** (2) 250W T10 Med QTZ

Wide Symmetric

LFB



- 2501** (1) 250W PS MH
- 2301** (1) 320W PS MH
- 2601** (1) 400W PS MH
- 2741** (2) 250W T10 Med QTZ

Symmetric Fluorescent

LFL



- 2831** (3) 39W TT FL
- 2841** (3) 40W TT FL
- 2851** (3) 50W TT FL
- 2861** (3) 55W TT FL
- 2380** (3) 80W TT FL
- 2871** (4) 39W TT FL
- 2881** (4) 40W TT FL
- 2891** (4) 50W TT FL
- 2454** (4) 54W T5HO FL
- 2801** (4) 55W TT FL
- 2480** (4) 80W TT FL
- 2654** (6) 54W T5HO FL

Forward Throw

LEI



- 5503** (2) 250W PS Mogul MH
- 5313** (2) 315W PS MH
- 5303** (2) 320W PS MH
- 5603** (2) 400W PS Mogul MH

Asymmetric

LFA



- 5503** (2) 250W PS MH
- 5303** (2) 320W PS MH
- 5603** (2) 400W PS MH
- 5723** (4) 250W T10 Med QTZ

Symmetric

LFA



- 5501** (2) 250W PS MH
- 5301** (2) 320W PS MH
- 5601** (2) 400W PS MH
- 5721** (4) 250W T10 Med QTZ

Wide Symmetric

LFB



- 5501** (2) 250W PS MH
- 5301** (2) 320W PS MH
- 5601** (2) 400W PS MH
- 5721** (4) 250W T10 Med QTZ

Asymmetric

LFU



- 5803** (1) 1000W BT37 MH

Forward Throw Fluorescent

LEI

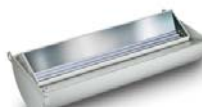

- 10815** (3) 28W T5HO FL
- 10816** (3) 32W T8 FL
- 10817** (3) 54W T5HO FL

Forward Throw

LEI



- 3603** (1) 400W PS MH
- 3703** (1) 750W PS MH
- 3503** (1) 875W PS MH
- 3803** (1) 1000W BT37 MH

Truss

Lightruss®

Durable construction that lasts.

Attention to detail.

Truss Sections

- A Truss Tubes**
 - Three metal tubes held in a triangular configuration by bulkheads.
 - Size 1: (3) 1.125" diameter steel tubes, available in section lengths up to 8'.
 - Size 2: (3) extruded 1.5" diameter aluminum tubes, available in section lengths up to 10'.
- B Wireway**
 - Delivered pre-wired and factory assembled.
- C Auxiliary Wireways**
 - Provision for multiple circuits and/or switching, please consult factory for multiple circuiting of size 1 Lightruss.
 - UL listed (US and Canada) for damp locations (Not recommended for exterior use).
- D Bulkhead**
 - Cast aluminum.
 - Provides vertical support of truss.
 - Point of attachment and adjustment for stainless steel cable or stem supports.
 - Splice compartment.

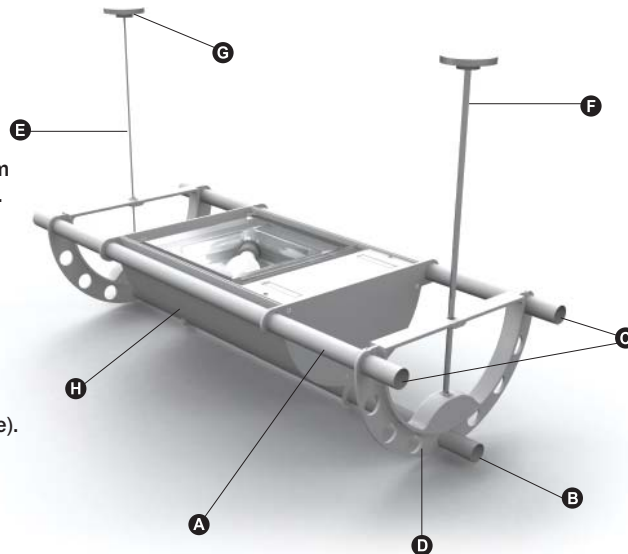

G Canopy Detail



D Splice Compartment

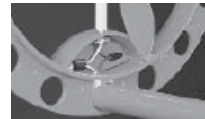

B Wireway Detail



Mounting

- E Cable**
 - Corrosion- and heat-resistant Inconel® aircraft suspension cable.
 - F Stem**
 - Power feed: 5/8" OD stainless steel stem, painted – specify color.
 - G Canopy**
 - 30° swivel and white plastic canopy.
 - Canopy twist locks into position with no exposed fasteners.
 - Inner steel support bracket attaches to 4" octagonal box.
- Wall Mount**
- Recessed outlet box.
 - Overhead suspension required for runs of 8' or more (size 1) and 10' or more (size 2).

Light Modules

- H Module Components**
 - Each light module houses lamp(s), optical assembly and ballast.
 - Light modules are made from 0.25" extruded aluminum side panels and 0.25" cast aluminum end caps.
 - Stainless steel set screws secure module to truss tubes.
 - All light modules are pre-wired, pre-focused and pre-assembled into the Lightruss system to simplify installation.
 - Light modules and Lightruss sections are individually packed and labeled to coordinate with the installation drawings.

Optics

Forward Throw

- HID and tungsten halogen modules utilize a segmented 95% reflective, specular aluminum reflector with an impact and heat-resistant, tempered glass lens.

Asymmetric and Symmetric

- HID and tungsten halogen modules utilize a brightened and anodized, hydroformed, aluminum reflector with an impact and heat resistant tempered glass lens.

Symmetric Fluorescent

- Modules have die-formed aluminum, 92% reflective superwhite reflector.

Integral Ballasts

HID

- HID Power Tray™ is supplied with a quick-connect plug.
- HID ballasts are (EISA) Energy Independence and Security Act compliant.
- Thermally protected.
- Class "B" sound rating.
- Silicone cushions are used in HID ballast mounting to minimize ballast noise and vibration in the system.
- Visit www.specspi.com/resources or contact factory for specific ballast information.

Fluorescent

- HPF electronic ballast with low harmonic distortion (<20%).
- Thermally protected.
- Minimum starting temperature is 0 °F.
- Class "A" sound rating.

Finishes

Powder Coat Paint

- Standard finish is thermoset polyester powder coat. All metal surfaces go through a 5-stage pretreatment process prior to powder coat application.
- Consult factory if natatorium (non-corrosive) finish is required.

Standard Options

- DM** Dimming (Fluorescent only)
- EMI** Integral Emergency
- EPT** Encapsulated Core and Coil Power Tray™
- F** Fusing (Factory installed)
- LD** Acrylic Prismatic Diffuser Lens
- LL** Downlight Louvers (For modules aimed in a direct orientation)
- Q** Standby Quartz Lighting
- QEM** Quartz Emergency Light Circuit

LD Option



LL Option



See Technical Information on page 300 for further details.

Lightruss FAQs

Q Is Lightruss easy to install?

- A Yes! You'll save approximately 25 to 30% in time and money versus independently hung fixtures. See page 35 for an installation estimate breakdown.

Q How is Lightruss installed, wired and mounted?

- A The completely assembled, wired and focused sections need only to be unpacked, lamped, ballasted, positioned and mounted as predetermined. Our HID multi-tap Power Tray™ with quick-connect plugs allow for fast installation, maintenance access and replacement. The bulkheads provide vertical support where stems and cables can attach at the splice compartment. Lightruss sections are joined at the end of each tube with an expansion bracket that provides positive locking action.

Q How many fixtures can be fed per power feed?

- A Size 2 Lightruss accommodates 12 gauge wiring and can service 8 dual 400W fixtures per power feed. Size 1 Lightruss accommodates 16 gauge wiring and can service 8 single 400W fixtures per power feed. All three tubes are UL listed as raceways and can house two circuits per tube. (All numbers assume a 277 volt, 20 amp system.)

Q How do I specify Lightruss?

- A A custom number is assigned (i.e. LT 12345) to the entire bill of materials, order, drawings and carton labels. Then our Lightruss team will work with you to design the system. When you approve the layout, we will build the system and send it to the job site for installation. For a detailed example of the Lightruss specification process, see page 36.

Q How do I determine which light module is needed?

- A The desired light levels determine light module selection and spacing. Our Lightruss team will assist in determining the appropriate combination of modules and lampings for your application.



Q Can Lightruss come in any length?

- A Composed of sections between 12 and 120 inches, Lightruss systems can be supplied in any length.

Q Why is Lightruss such a good choice for natatoriums?

- A Our lighting system installs over the pool deck, lowering maintenance costs. Indirect lighting eliminates water surface glare, allowing lifeguards to see directly to the bottom of the pool. Standard size 2 Lightruss system's all aluminum components are anodized and powder coated with a 2 mil thickness polyester powder coat paint for a non-corrosive finish and all hardware is suitable for natatorium environments. Consult factory for size 1 Lightruss in a natatorium application.

Q Are Lightruss systems built with high-quality components?

- A Yes! Lightruss was carefully designed and all details were considered. Machine tolerances on all components are held to within +/- .030" and silicone cushions ensure quiet system operation.

Q How are security equipment, auxiliary lighting and other accessories integrated into Lightruss systems?

- A The three-tube system can serve as independent wire raceways for multiple circuits, track lighting or incorporation of additional needs such as security cameras, sound systems or signage. Empty modules can serve as a place to conceal speakers and additional equipment.

Q Can I specify specific circuitry schemes?

- A Yes! We can work with the engineer to incorporate different light levels with different wiring schematics (i.e. 3 phase or phase to phase).

Q Are Lightruss light modules enclosed?

- A HID and quartz light modules are supplied with a removable, tempered glass lens. A lens option is available for fluorescent modules.